

For Health Hazard Applications

Job Name _____
 Job Location _____
 Engineer _____
 Approval _____

Contractor _____
 Approval _____
 Contractor's P.O. No. _____
 Representative _____

Series 009

Reduced Pressure Zone Assemblies

Sizes: 1/4" – 2"

Series 009 Reduced Pressure Zone Assemblies are designed to protect potable water supplies in accordance with national plumbing codes and water authority requirements. This series is designed to protect drinking water supplies from dangerous cross-connections in accordance with national plumbing codes and water authority requirements for non-potable service applications such as irrigation, fireline, or industrial processing.

This series features two in-line, independent check valves, captured springs and replaceable check seats with an intermediate relief valve. Its compact modular design facilitates easy maintenance and assembly access. Sizes 1/4" – 1" shutoffs have tee handles.

Features

- Single access cover and modular check construction for ease of maintenance
- Top entry - all internals immediately accessible
- Captured springs for safe maintenance
- Internal relief valve for reduced installation clearances
- Replaceable seats for economical repair
- Bronze body construction for durability 1/4" – 2"
- Ball valve test cocks — screwdriver slotted 1/4" – 2"
- Large body passages provides low pressure drop
- Compact, space saving design
- No special tools required for servicing

Specifications

A Reduced Pressure Zone Assembly shall be installed at each potential health hazard location to prevent backflow due to backsiphonage and/or backpressure. The assembly shall consist of an internal pressure differential relief valve located in a zone between two positive seating check modules with captured springs and silicone seat discs. Seats and seat discs shall be replaceable in both check modules and the relief valve. There shall be no threads or screws in the waterway exposed to line fluids. Service of all internal components shall be through a single access bronze cover secured with stainless steel bolts. The assembly shall also include two resilient seated isolation valves, four resilient seated test cocks and an air gap drain fitting. The assembly shall meet the requirements of: USC; ASSE Std. 1013; AWWA Std. C511-92; CSA B64.4. Shall be a Watts Series 009.

†Does not indicate approval status. Refer to Page 2 for approved sizes & models.

Watts product specifications in U.S. customary units and metric are approximate and are provided for reference only. For precise measurements, please contact Watts Technical Service. Watts reserves the right to change or modify product design, construction, specifications, or materials without prior notice and without incurring any obligation to make such changes and modifications on Watts products previously or subsequently sold.



009QT-S



009M2QT

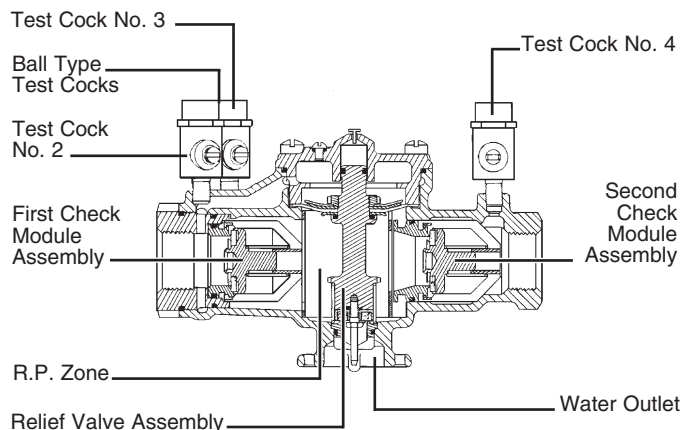

Now Available
WattsBox Insulated Enclosures.

For more information, send for literature ES-WB.

NOTICE

Inquire with governing authorities for local installation requirements

WATTS®

Available Models: 1/4" – 2"

Suffix:

- QT – quarter-turn ball valves
- S – bronze strainer
- LF – without shutoff valves
- AQT – elbow fittings for 360° rotation
3/4" – 2" only
- PC – internal Polymer Coating
- SH – stainless steel ball valve handles
- HC – 2 1/2" inlet/outlet fire hydrant fitting (2" valve)

Prefix:

- C – clean and check strainer
3/4" – 1" only
- U – union connections (see ES-U009)

Materials: 1/4" – 2"

Bronze body construction, silicone rubber disc material in the first and second check plus the relief valve. Replaceable polymer check seats for first and second checks. Removable stainless steel relief valve seat. Stainless steel cover bolts.

Standardly furnished with NPT body connections. For optional bronze union inlet and outlet connections, specify prefix U (1/2" – 2"). Series 009QT furnished with quarter turn, full port, resilient seated, bronze ball valve shutoffs.

A+NZ model in DR brass with BSP body connections

Pressure / Temperature

Series 009 1/4" – 2" Suitable for supply pressure up to 203psi (14 bar). Water temperature: 33°F – 194°F (0.5°C – 90°C).

Standards

- USC
- ASSE No. 1013
- AWWA C511-92
- CSA B64.4
- IAPMO File No. 1563.
- AS/NZS 2845.1

†Does not indicate approval status. See below for approved models.



Approvals

ASSE, AWWA, CSA, IAPMO, WaterMark

Approved by the Foundation for Cross-Connection Control and Hydraulic Research at the University of Southern California.

UL Classified 3/4" – 2"

(LF models only except 009M3LF)

WaterMark applicable to A+NZ models

Air Gaps and Elbows

MODEL	DRAIN OUTLET	DIMENSIONS				WEIGHT		
		for 909, 009 and 993 sizes		A		B		lbs.
	in. mm	in. mm	in. mm	in. mm	lbs.	kgs.		
909AGA	1/4" - 1/2" 009, 3/4" 009M2/M3	1/2 13	2 3/8 60	3 1/8 79	0.625	0.28		
909AGC	3/4" - 1" 009/909, 1" - 1 1/2" 009M2	1 25	3 1/4 83	4 7/8 124	1.5	0.68		
909AGF	1 1/4" - 2" 009M1, 1 1/4" - 3" 009/909, 2" 009M2, 4" - 6" 993	2 51	4 3/8 111	6 3/4 171	3.25	1.47		
909AGK	4" - 6" 909, 8" - 10" 909M1	3 76	6 3/8 162	9 5/8 244	6.25	2.83		
909AGM	8" - 10" 909	4 102	7 3/8 187	11 1/4 286	15.5	7.03		
909ELA	1/4" - 1/2" 009, 3/4" 009M2/M3	-	-	-	-	-		
909ELC	3/4" - 1" 009/909	-	2 3/8 60	2 3/8 60	0.38	0.17		
* 909ELF	1 1/4" - 2" 009M1, 1 1/4" - 2" 009/909, 2" 009M2, 4" - 6" 993	-	3 5/8 92	3 5/8 92	2	0.91		
* 909ELH Vertical	2 1/2" - 3" 009/909	-	-	-	-	-		

* Epoxy coated

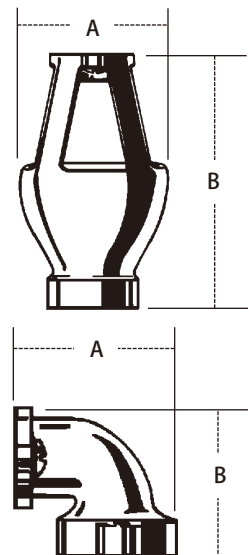

Dimensions and Weight: 1/4" – 2" 009

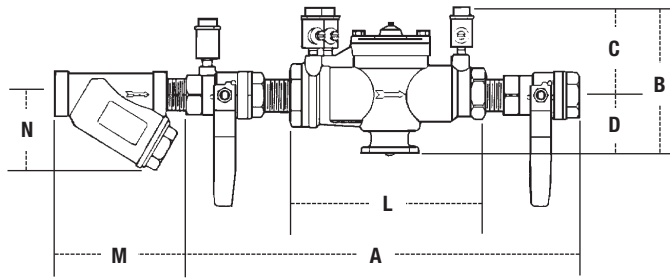

009 1/4" – 2"

SIZE	DIMENSIONS (APPROX.)										STRAINER DIMENSIONS		WEIGHT			
	A		B		C		D		L		M		N		lbs.	kg.
in.	in.	mm	in.	mm	in.	mm	in.	mm	in.	mm	in.	mm	in.	mm		
1/4	10	250	4 5/8	117	3 3/8	86	1 1/4	32	5 1/2	140	2 3/8	60	2 1/2	64	5	2
3/8	10	250	4 5/8	117	3 3/8	86	1 1/4	32	5 1/2	140	2 3/8	60	2 1/2	64	5	2
1/2	10	250	4 5/8	117	3 3/8	86	1 1/4	32	5 1/2	140	2 3/4	70	2 1/4	57	5	2
3/4	10 3/4	273	5	127	3 1/2	89	1 1/2	38	6 3/4	171	3 3/16	81	2 3/4	70	6	3
1	14 1/2	368	5 1/2	140	3	76	2 1/2	64	9 1/2	241	3 3/4	95	3	76	12	5
1 1/4	17 3/8	441	6	150	3 1/2	89	2 1/2	64	11 3/8	289	4 7/16	113	3 1/2	89	15	6
1 1/2	17 7/8	454	6	150	3 1/2	89	2 1/2	64	11 1/8	283	4 7/8	124	4	102	16	7
2	21 3/8	543	7 3/4	197	4 1/2	114	3 1/4	83	13 1/2	343	5 15/16	151	5	127	30	13

Suffix HC – Fire Hydrant Fittings dimension 'A' = 25"

Capacity

Performance as established by an independent testing laboratory. *Typical maximum system flow rate (7.5 feet/sec., 2.3 meters/sec.)

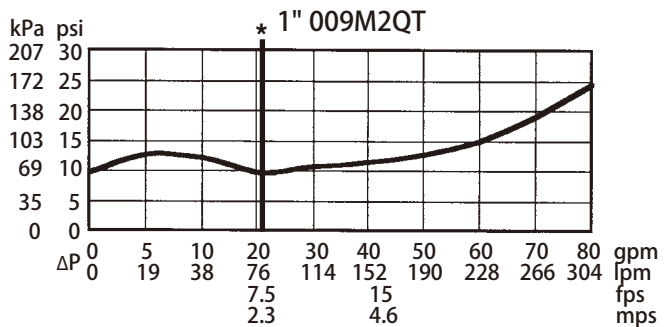
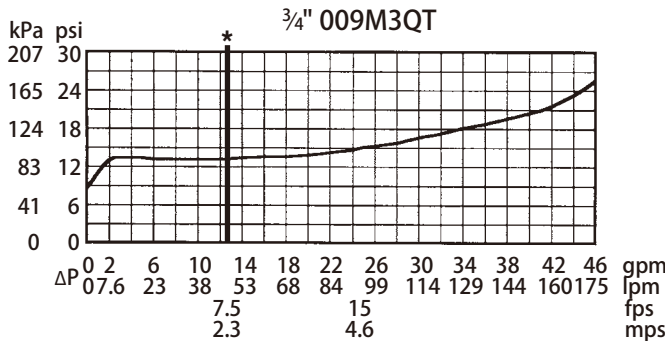
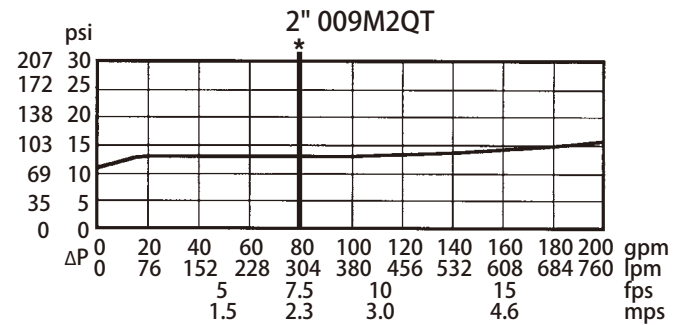
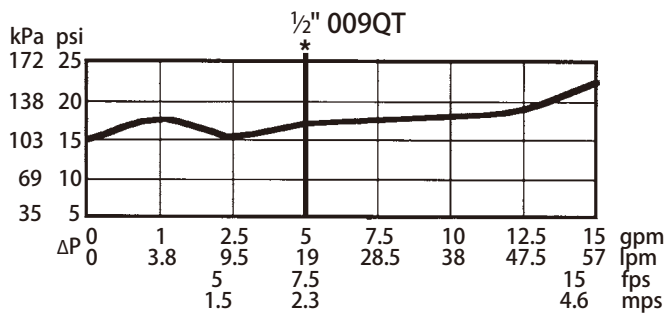
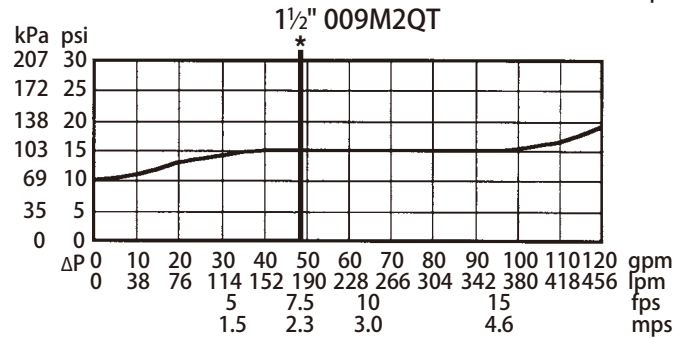
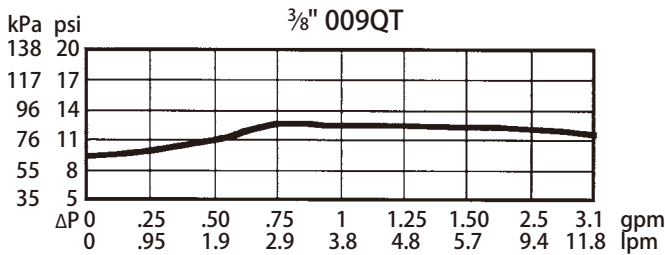
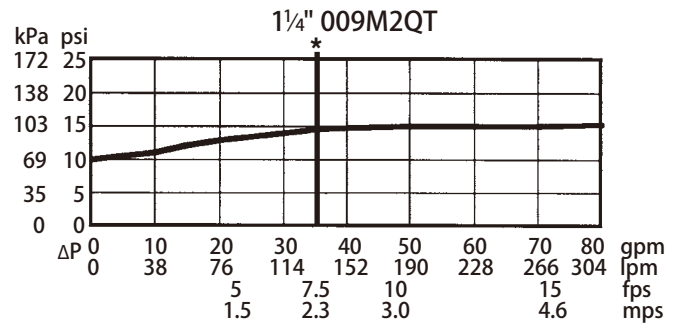
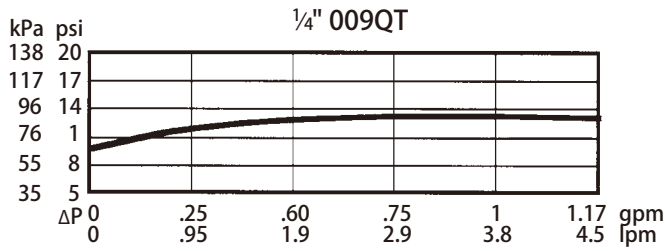

USA: Tel: (978) 688-1811 • Fax: (978) 794-1848 • www.watts.com
 Canada: Tel: (905) 332-4090 • Fax: (905) 332-7068 • www.watts.ca